

Assembly instruction

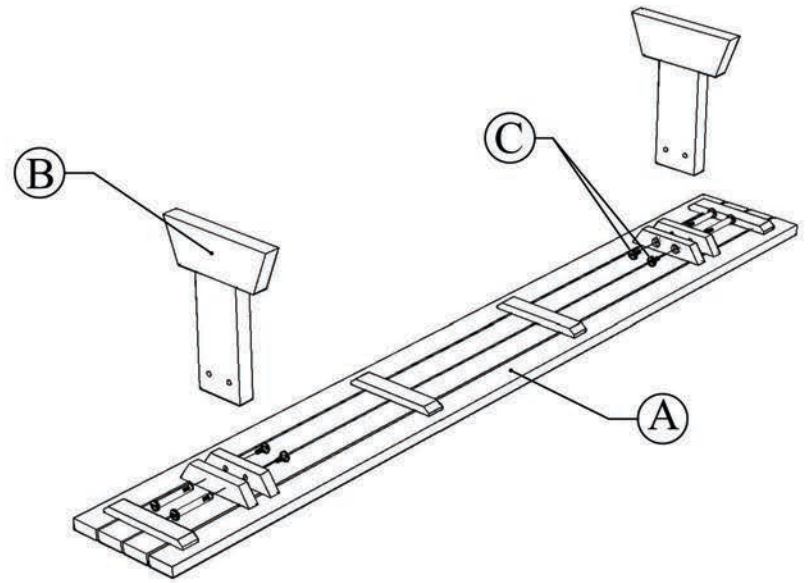

A 1

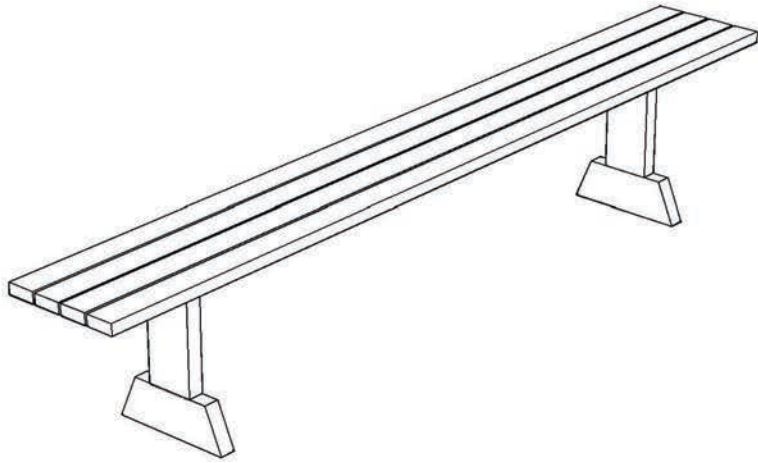

B 2

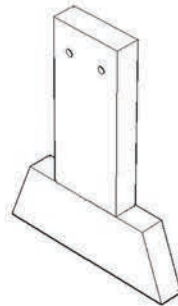

C 4

