

ASSEMBLY INTRUCTION





JULITA 1550
1550 x 900 x H730 mm

BUYER :
BRAFAB
ref: 4493

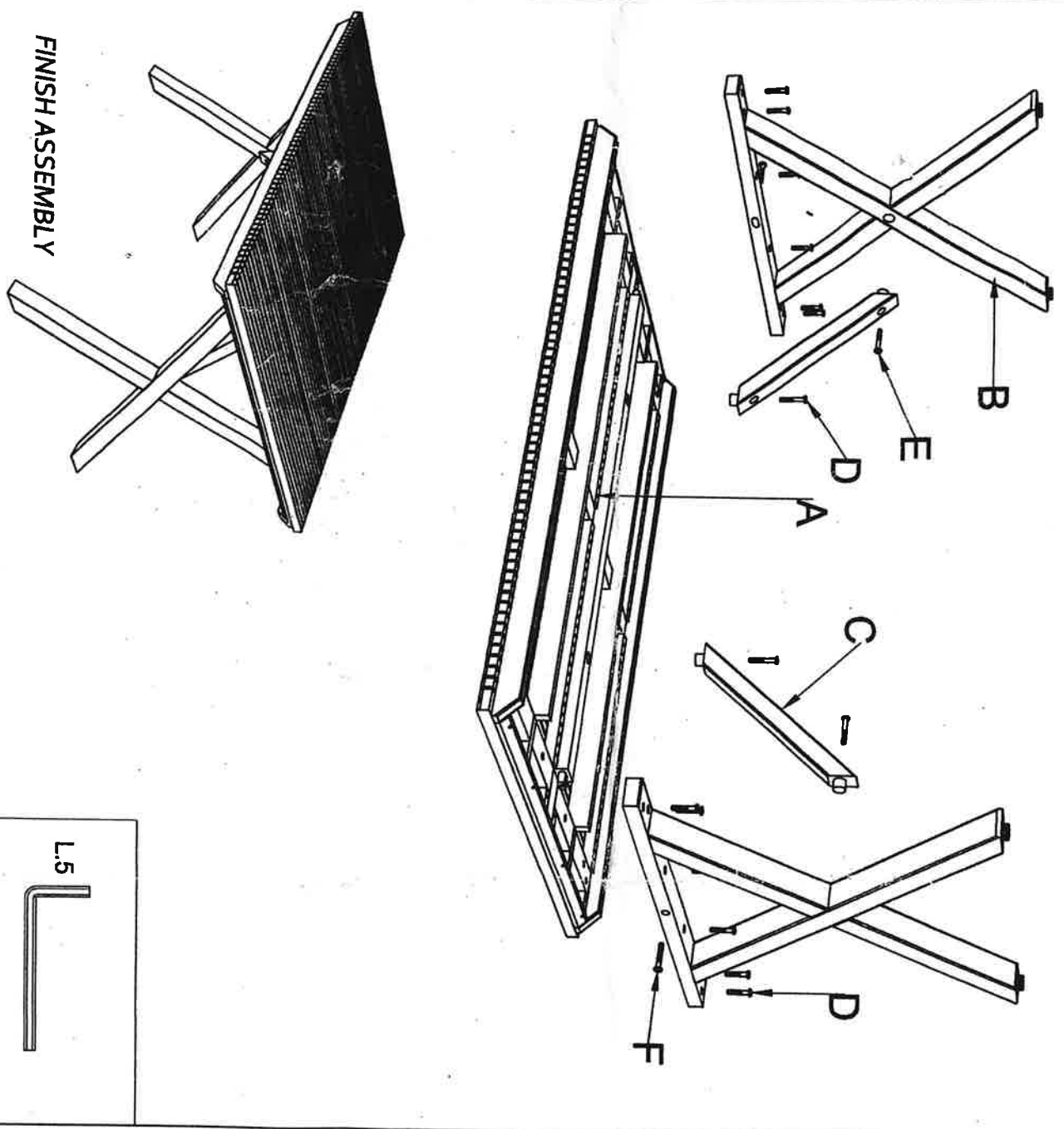
MATERIAL OF PART

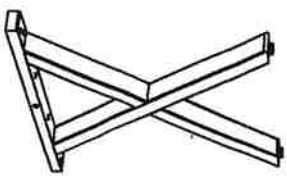
COMPONENT



POST.	QTY.	MATERIAL OF PART
A	1	
B	2	
C	2	
D	14	 40 mm
E	2	 50 mm
F	2	 60 mm



FINISH ASSEMBLY